

THE EXPERTS

for fire protection in electrical installations

40
YEARS
OF EXPERIENCE



Building Connections

OBO
BETTERMANN

40
YEARS
OF EXPERIENCE

The experts for fire protection in electrical installations

OBO Bettermann has offered products and solutions for electrical installations for over 100 years. Our focus has always been particularly directed towards building protection and safety. This is because electrical installations pass through buildings like a network and need special protection.

As experts in electrical installation, we at OBO detected early on how important professional fire protection matched to the individual situation is. The area of fire protection has now belonged to our OBO range for more than 40 years. Since that time, we have not only supplied cable routing systems or devices to our customers, but have also equipped them with the knowledge and required products to make the whole system safe in the event of fire.

Today, electricity is the #1 cause of fire - if it is not sufficiently protected. For this reason, planners, architects and installation engineers must consider comprehensive fire protection at an early stage and ensure that fire protection building work is carried out correctly and that it is ready for approval.

In such a sensitive area as fire protection, it can be helpful or even necessary to obtain support and expert advice! Whether for a first overview, an individual consultation or the development of special solutions - as fire protection experts, my colleagues and I will act as responsible helpers. And not least because our OBO fire protection products ensure maximum safety in the event of fire.

With our products and our comprehensive consultation, we can cover all three fire protection aims. We can help to limit the spread of the fire. We can protect emergency and escape routes. And we can also maintain the function of the electrical systems if there is a fire. How you can achieve the three protection aims in individual cases will be explained on the following pages using various application examples.

Of course, the examples described here cannot answer every question, because individual solutions are frequently required for careful fire protection. For this reason, you can find all the information on our Support service on P. 24/25. Rely on your fire protection experts and contact us about any matter to do with fire protection and safety in the field of electrical installations.



"We fire protection experts are also responsible for safe electrical installations."

Dipl.-Ing. (FH) Stefan Ring
Head of the Fire Protection Systems Business Unit BSS

"As a trained fireman and with over 30 years of experience in combative and preventive fire protection, I know how to estimate dangers exactly - and to act against them in a professional manner."



The three protection aims

Preventive fire protection saves people's lives and property. Three points are fundamentally important when it comes to saving people's lives and protecting property against fire. Forty years of experience with fire protection in the field of electrical installations and a unique product range make OBO one of the few providers who cover all three protection aims of construction fire protection:



1

1. Limit the spread of fire

In buildings planned with fire protection, fire and smoke are prevented from spreading quickly. Here, insulation systems and cable bandages are used. These measures prevent the fire from spreading to other parts of the building.



2

2. Protect escape and rescue routes

If there is a fire, saving people's lives takes top priority. This is why emergency and escape routes are the central lifelines of any building. They must be planned and constructed to be fireproof and remain usable under all circumstances.



3

3. Maintain electrical functions

If there is a fire, important technical equipment, such as fire alarm systems, extraction systems or emergency lighting, must continue to function. This allows safe evacuation and the fire brigade is supported in fighting the fire. Fireproof cable systems and cable support systems are essential here.



40
YEARS
OF EXPERIENCE

Fire protection explained using examples

The OBO Fire Protection House

How can the three protection aims be achieved in concrete terms? Using our example building, we will show you over the coming pages where fire protection measures are required and how they can be implemented.

Even if fire protection systems are frequently barely noticed in the finished building - you will see that fire protection has a role to play in every building area and how it requires exact planning! Not least because fire protection measures have been a statutory requirement for a long time now.

1. Limit the spread of fire
2. Protect escape and rescue routes
3. Maintain electrical functions

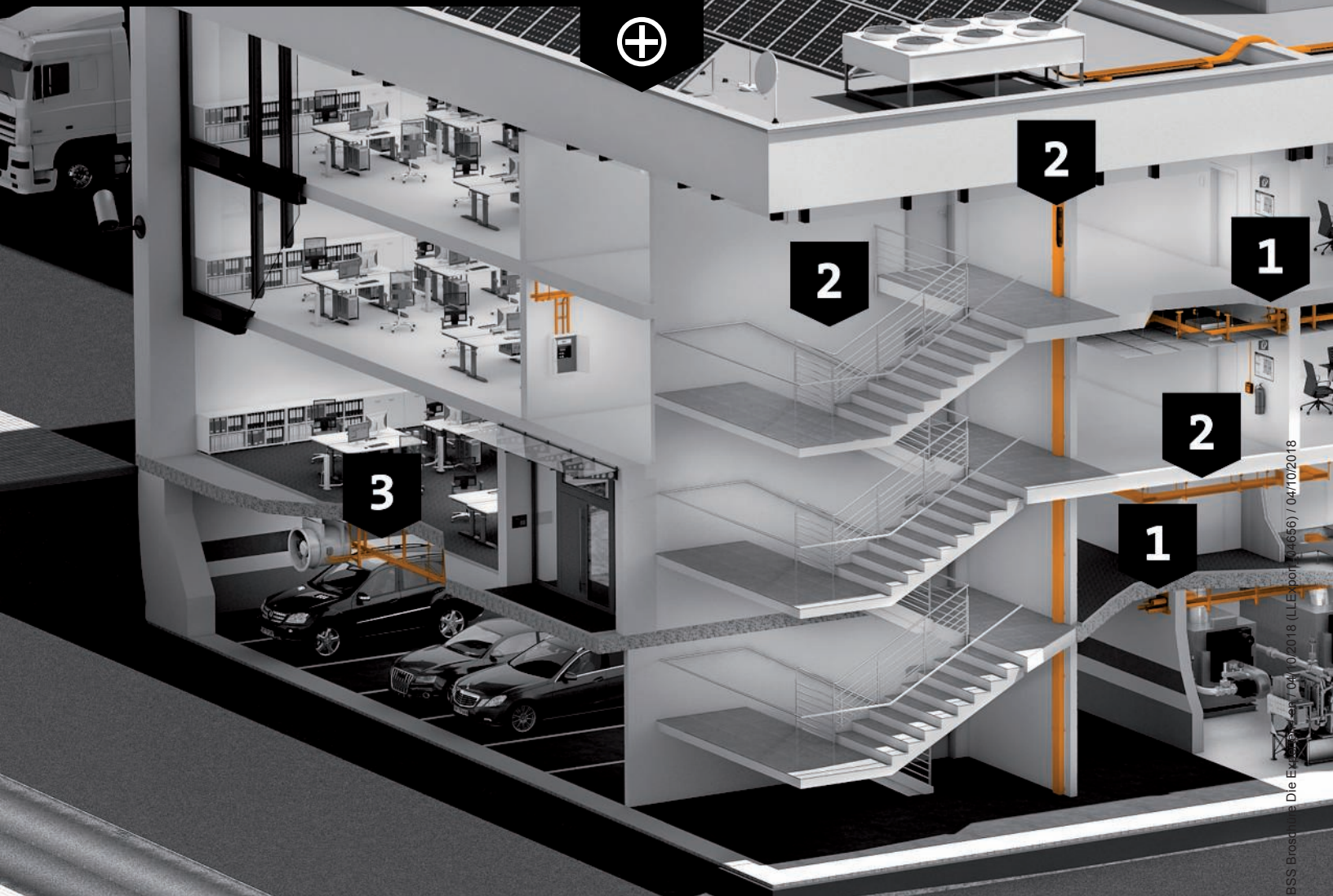

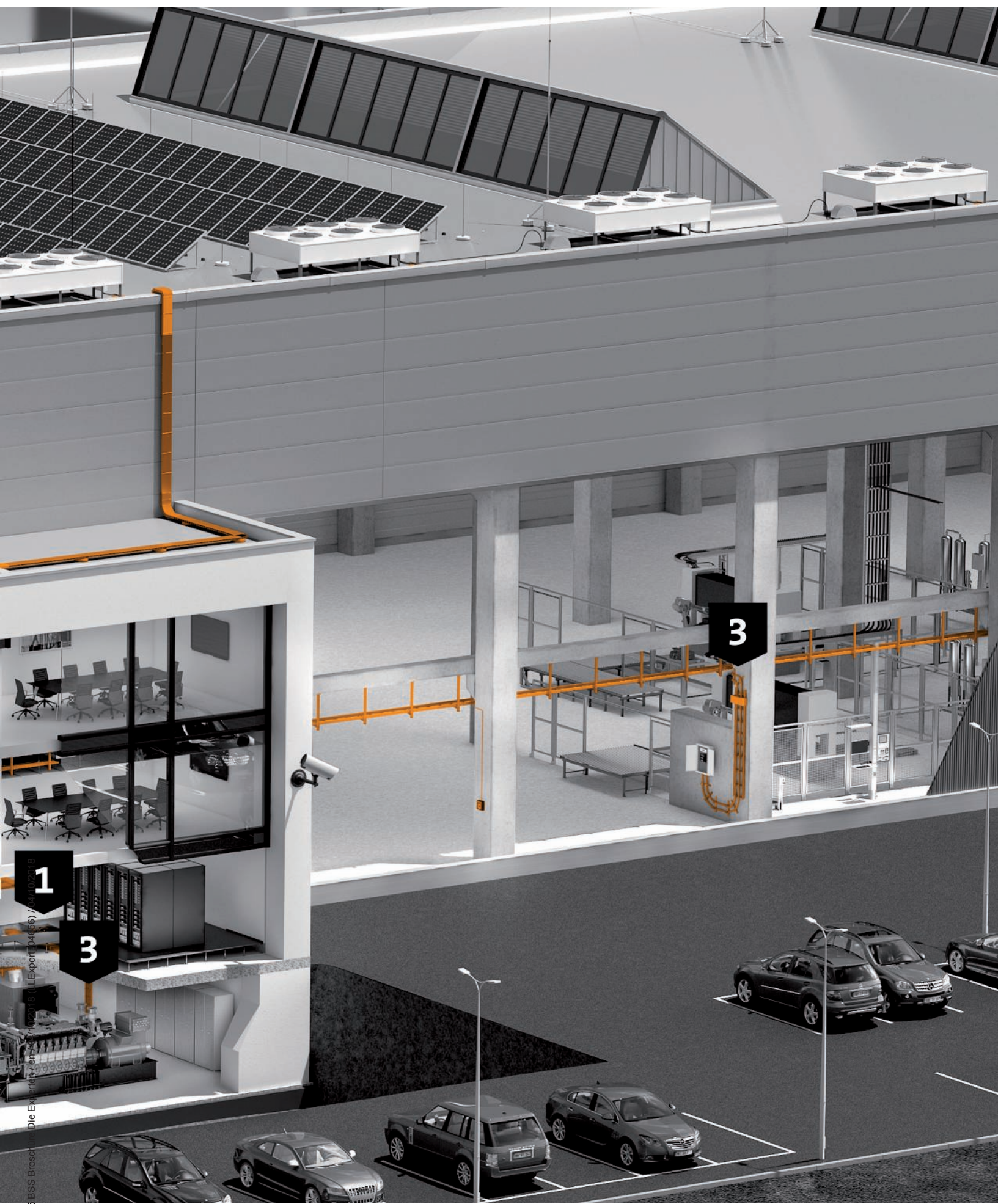

05 BSS Broschüre - Die Experten (LE-Export) D4(66) / 04.07.2016

1

Protection aim 1: Limit the spread of fire

To prevent the fire from spreading to other parts of the building, the installations required for ceiling and wall penetrations must be reliably sealed. This is done using insulation systems, which effectively prevent the spread of fire and smoke.

We fire protection experts divide a building up into individual fire sections, which are protected by insulation. Thus, if there is a fire, all the building sections not directly affected by the fire are protected for a certain period of time, as the fire cannot spread directly.

We can protect people and property through structural measures and can help the fire brigade to isolate the fire with extinguishing measures.

Different requirements and installation situations always require suitable solutions. This is why we at OBO are always available to the electrical installation professionals as an adviser about structural fire protection.

Here, we show you a few examples of how insulation can be applied effectively.



To prevent the spread of the fire, fire sections are separated from one another. In our example, a technical room is safely protected. High fire loads due to large quantities of cables are encapsulated by the high fire resistance period of the room. Cable penetrations through walls are closed off with cable and combination insulation to stop fires.

Insulation is also required above false ceilings. Data and power cables and the necessary insulation are thus outside the field of vision and are not noticed. The insulation can usually be reached easily via the inspection openings in the false ceiling.



A sensitive area which is frequently forgotten: The underfloor cables. But the area under the system floor must also be well insulated. In server rooms with system floors, dust and fibre-free systems are suitable, as great emphasis is placed on cleanliness.

Application example Insulation

1

Protection aim 1

Insulation in practice

Limiting the spread of fire and smoke

Safe cable insulation is essential for effective fire protection. Only in this way is it possible to prevent the spread of fire and dangerous smoke.

The OBO fire protection experts recommend the PYROPLUG® Peg insulation system, as it can be mounted completely cleanly and without dust or fibres. This means that it can also be used in sensitive areas such as in data processing rooms or laboratories.

In this system, core drill holes in solid walls and concrete ceilings are closed off with FBA plugs made of permanently elastic, closed-pore foam. Eight different sizes are available. Residual joints are simply closed off with filler.

Special tools are not required for mounting. Retro-installations of cables are also possible with the minimum of effort.

1

2





Ideally, planners and electricians specify the right insulation system together. If they choose PYROPLUG® Peg, then the suitable plug must be selected.



The installation engineer cuts the plugs according to the cable assignment. Then they are pressed into the wall opening quickly and cleanly on both sides - without dust or fibres. Installation must always take place according to the approval.

Residual joints are closed off with the 1-component filler PYROPLUG® Screed. An identification plate is applied to the insulation as documentation.

2

Protection aim 2: Protect escape and rescue routes

If there is a fire, heat and smoke development pose a risk to human lives. Escape and rescue routes guide people out of the building along safe routes and act as a point of attack for the fire brigade. For this, the routes must also be safely accessible in the event of fire.

For fire experts, saving people's lives is the top priority. This is why we place particular emphasis on safe escape and rescue routes. They must be designed in such a way that any electrical installation does not represent an additional fire load.

We at OBO are happy to help you with our knowledge and wide-ranging product range to equip your escape and rescue routes.

Our false ceiling systems ensure a safe installation.

In addition, we offer two different variants of fire protection ducts: The internally coated PYROLINE® Rapid and PYROLINE® Con made of fibre-glass reinforced lightweight concrete. Both are ideal solutions for the encapsulation of fire loads in escape and rescue routes.





With installations above suspended fire protection ceilings, particular care is required: If there is a fire, the ceiling must not be stressed or damaged by falling or deforming parts. Cable support systems used here must be designed to be safe in the event of fire and offer a large selection, in order to adapt themselves optimally to the cable volume to be routed and to the available installation space.



Fire protection experts treat the stairwell as an individual fire section, which requires special protection. It serves as the most important escape and rescue route to the outside, as well as an access route for fire brigades. To protect the escape route against cable fires and dangerous smoke development, the fire load must be effectively encapsulated.

The OBO fire protection ducts can be run through fire resistance-compatible walls, without the need for additional insulation. The installation can take place directly on walls and ceilings or, as shown here, using a suspension system. Simple retro-installation is also possible: The ducts can be quickly inspected and can be reassigned at any time.

Application example: Escape and rescue routes

2

Protection aim 2

Fire protection ducts in practice

For safe escape and rescue routes

To ensure that no dangerous smoke is created in the area of escape and rescue routes, it is essential that cable fires are prevented. Fire protection ducts are a safe solution here, as they actively encapsulate the fire load, thus preventing the spread of a fire.

As part of the OBO fire protection products, you will find, amongst other things, the PYROLINE® Rapid duct system, which, together with many different fittings and a comprehensive range of accessories, can offer a high level of flexibility.

The internally coated fire protection ducts can be mounted both directly on the wall or ceiling, on the raw floor or in the system floor, and also with the suspension system.





The installation engineer can choose between three different dimensions for various cable volumes. The ducts are delivered in lengths of 2 metres and are thus also suitable for simple, rapid section mounting.



With the PYROLINE® Rapid duct system, the electrician can simply snap on the lid after installing the cables - without the use of screws or tools. Connectors provide smoke closure: The closing contour between the lid and base provides effective sealing.

For the fire protection ducts, many different fittings are available for horizontal or vertical changes of direction. Here, the installation engineer is mounting a flat angle after having installed the cables beforehand.

3

Protection aim 3: Maintain electrical functions

A fire occurs and there's no power? This worst-case scenario must be avoided at all costs! The function of safety-relevant electrical systems is essential in the event of a fire. Important powered equipment such as emergency lighting, fire alarm systems or smoke extraction systems must continue to function for a sufficiently long time.

As fire protection experts, we pay particular attention to maintaining the supply of electricity to all the safety-relevant electrical systems. This is because in the event of a fire, powered technical equipment is used whose failure would mean a major safety risk to people.

In public buildings and structures such as hospitals, hotels, stadia or theatres, maintaining the supply of electricity is even required by law.

For safe evacuation, the provision of safety lighting, fire alarm and smoke extraction systems must be guaranteed for a defined period of time. The same applies to fire alarm systems and the operation of lifts with fire controls.

To support effective firefighting, maintaining the supply of electricity should also be guaranteed after a fire breaks out. Thus, for example, the supply of extinguishing water and the functioning of fire brigade lifts should be secured.

We at OBO gladly offer our advice and information about our products, to help you achieve these important aims.



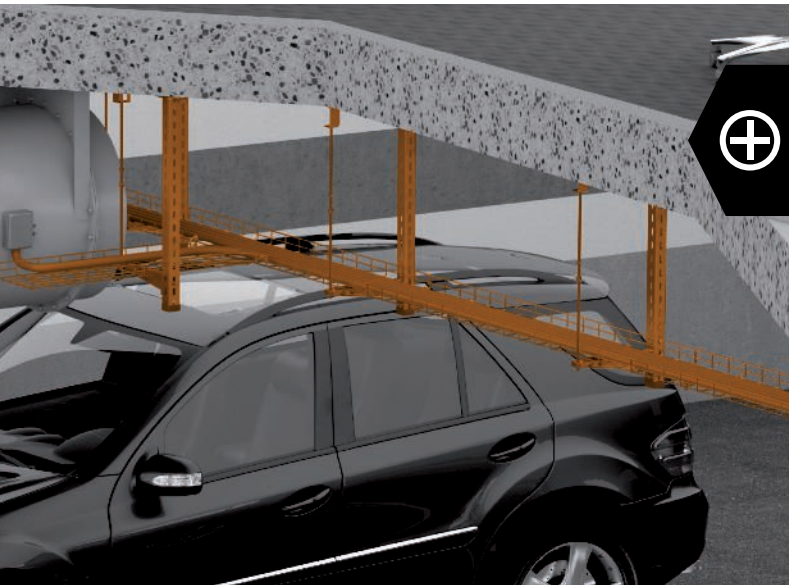

If a fire breaks out in an underground car park, it can quickly lead to the development of an enormous level of smoke. For safe evacuation, the operation of smoke extraction systems must therefore be guaranteed. Through the extraction of the developing heat, the entire building structure is simultaneously protected. And, of course, with good smoke extraction, fire brigades can better localise the centre of the fire.

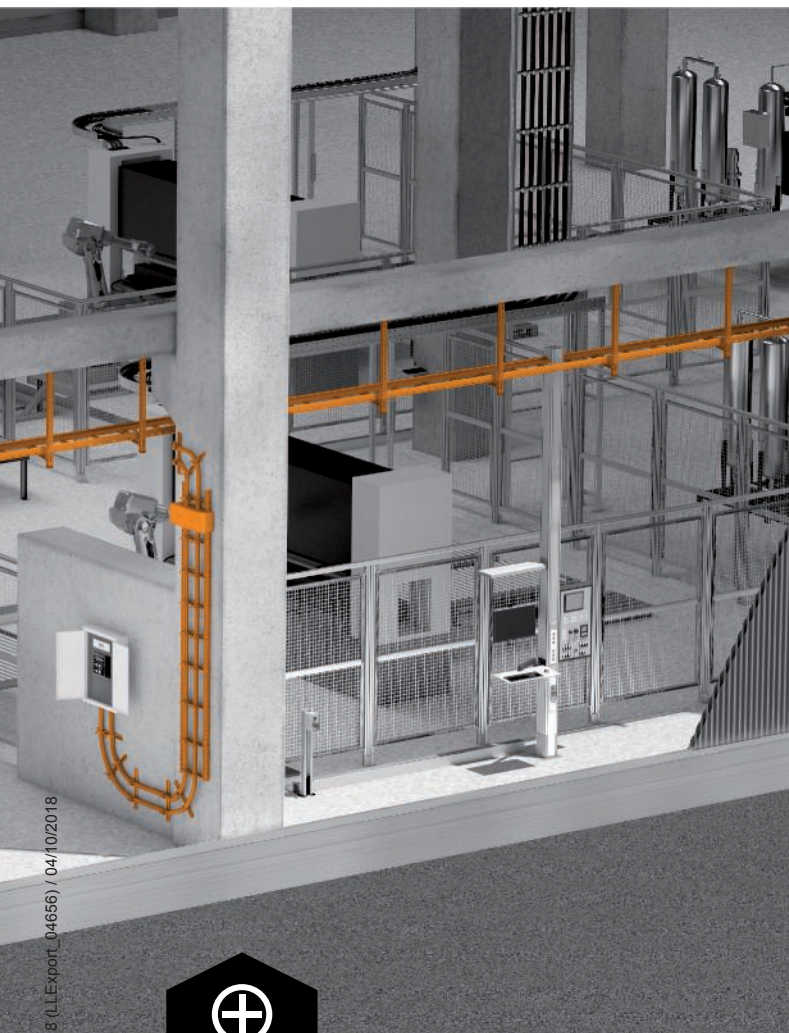

Systems for maintaining the supply of electricity are available in different installation variants. All the systems can be installed both horizontally and vertically. The selection is made depending on the installation route and volume of cables. A fire alarm control centre can be integrated in the safety system of the building.

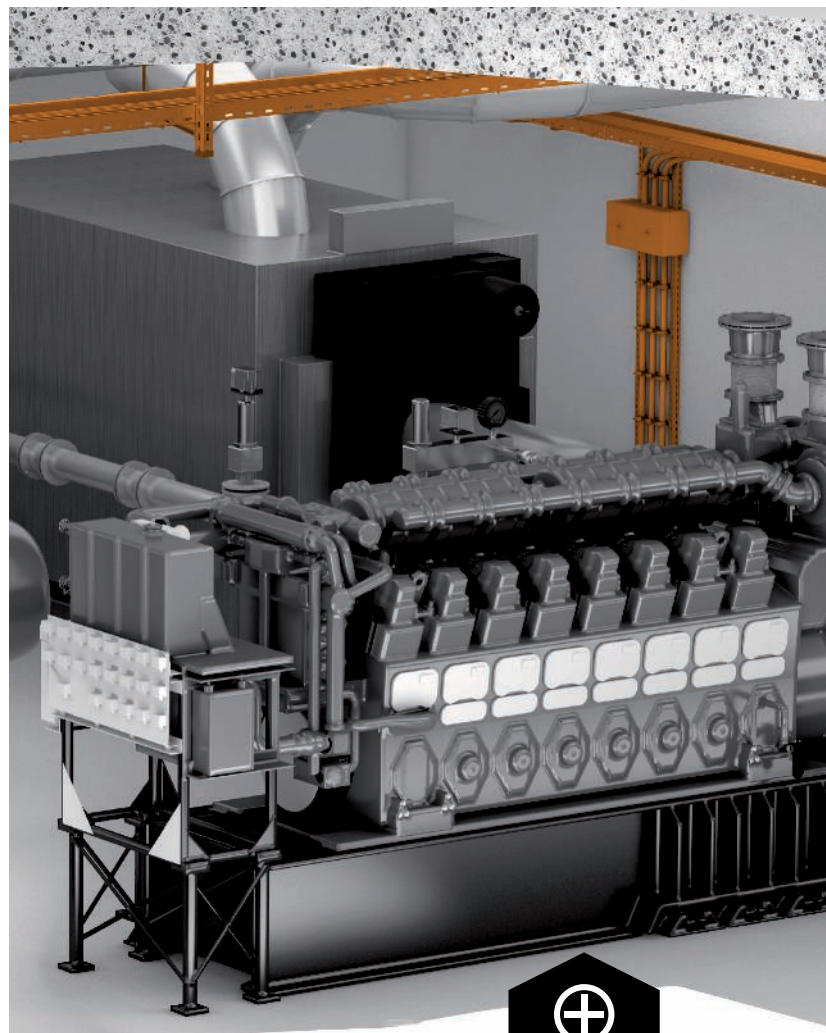

The emergency power supply is the core of the safety-relevant electrical system. This requires special protection in order to ensure the continued supply of electricity in the event of fire.

Application example: Maintain electrical functions

3

Protection aim 3

Fireproof cable support systems in practice

For maintaining supply of electrical systems

To ensure that electrical systems continue to function in the event of a fire, cable systems must withstand special fire tests. The OBO routing systems fulfil these special requirements.

Often, to maintain the electrical supply must also be ensured in challenging or even aggressive atmospheres, as in our example: a road tunnel.

The OBO RKS-Magic cable tray is particularly suitable here, as it is made of, amongst other things, rustproof steel and can also be installed under the ceiling in a space-saving manner. The tested screwless joint connection allows particularly fast, simple and safe mounting.

2





The installation engineer always selects the material of the cable trays according to the existing regulations. In our road tunnel, section mounting takes place with a special tunnel clamp made of rustproof steel. Alternatively, many other mounting versions are also available, e.g. with suspended supports and brackets.

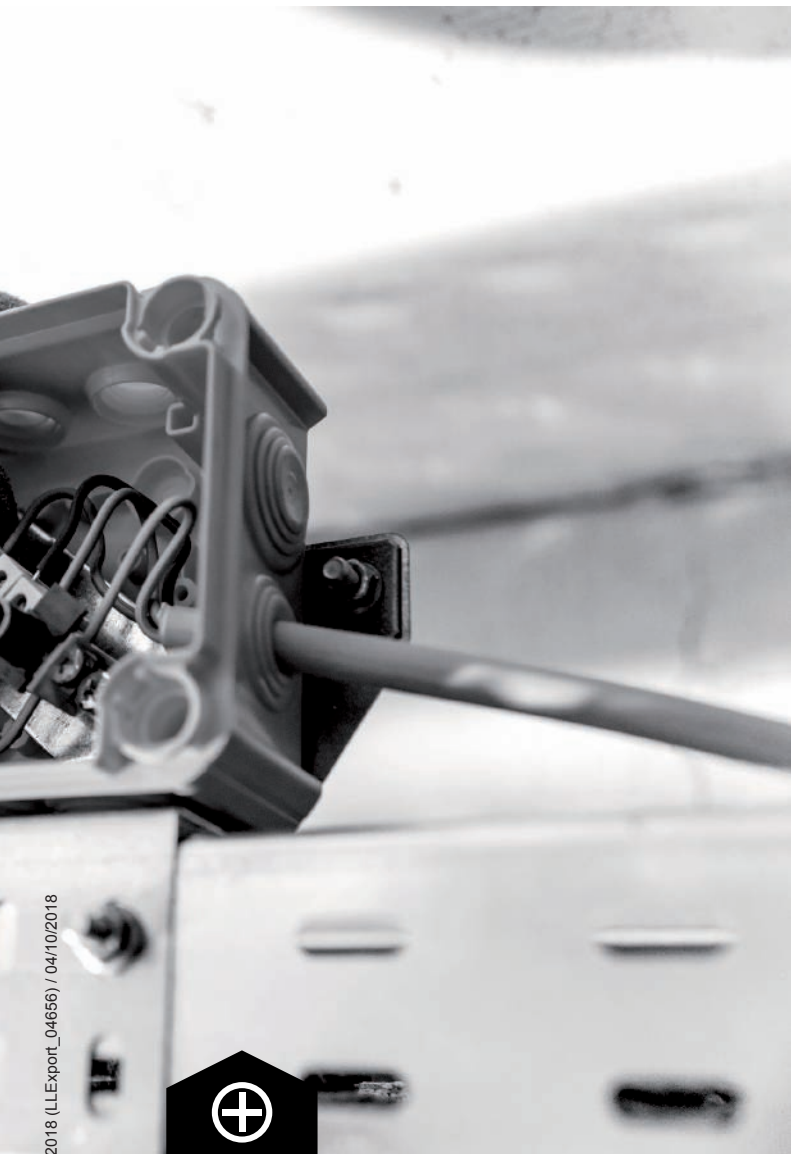

Junction boxes, which protect the cables against external influences such as dust and water, are used to branch and extend the cables. Here, the OBO FireBox is installed directly on the tray. Alternatively, mounting on the wall or ceiling is also possible. A fireproof connection of wires is ensured through ceramic terminals.

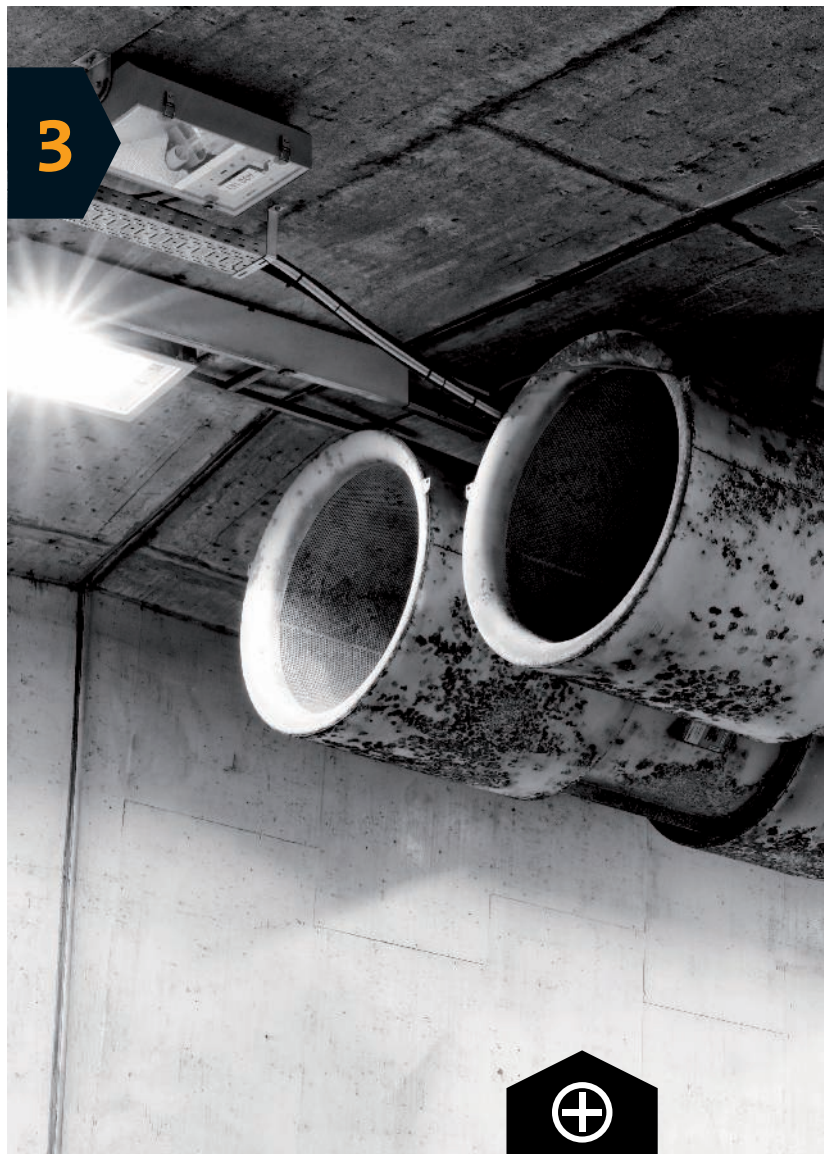

In closed spaces, such as tunnels, maintaining the electrical supply of ventilation devices and tunnel lighting is particularly important. In our example, it is now ensured. Thus, in the event of fire, the smoke extraction fan can be operated safely and extract the lethal smoke. People can be evacuated safely.

Special solutions

When "standard" is not sufficient

Maintenance of the fire sections, securing of escape routes and maintaining the electrical supply: depending on the building, very different solutions are necessary or possible, in order to cover all three protection aims safely. Frequently, special solutions are also necessary, e.g. if fire protection technology is to be retro-installed in old and existing buildings.

If standard solutions are no longer sufficient for installing safe fire protection technology, planners, architects and installation engineers rapidly come up against their limits. It's therefore good that there are fire protection experts who can give you advice and who can identify adapted solutions!

With 40 years of experience in fire protection, OBO is a reliable partner with regard to building-specific special solutions. Our fire protection experts can look back on many implemented projects and, with each new case, reach agreements with all those involved. We can find feasible and economic special solutions for even the trickiest cases which can also be implemented quickly.

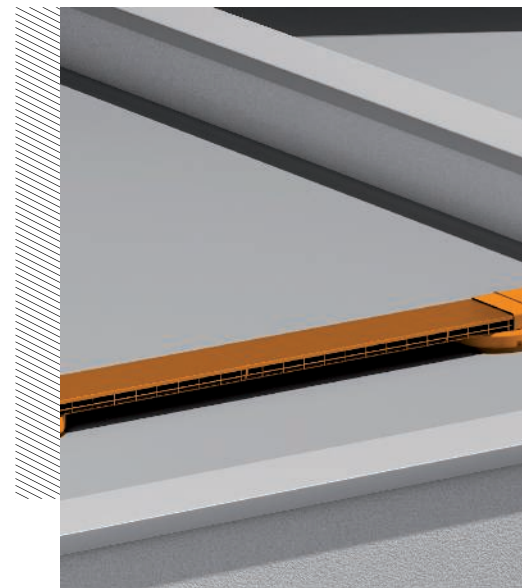

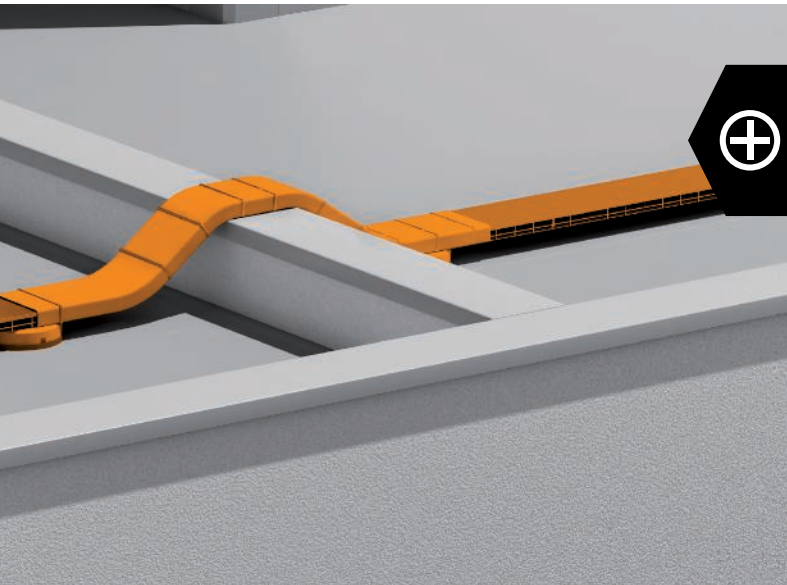

Special solutions must often be found for external areas of buildings. Cable bandages to prevent the spread of fire must, for example, be weatherproof. Here, this is achieved with the OBO PYROWRAP® Wet cable bandage. It is also suitable for additional special applications, e.g. in offshore areas or power station construction.



Sensitive building areas, such as this server room, require special protection. Here, a special solution can provide double assistance: Fire protection ducts are routed under the raised floor. If there is a cable fire, the fire and smoke cannot spread unimpeded in the raised floor. In our example, the OBO PYROLINE Rapid® fire protection duct made of internally coated sheet steel is used.

Tested quality

Fire protection without compromises



There can be no compromises with fire protection: In an emergency, every product used must function absolutely reliably and also comply with legal and construction regulations. As an OBO customer, you can rely on tested quality. Our fire protection experts subject every newly developed product to comprehensive tests in accredited testing institutes. In doing so, we orientate ourselves to national and international testing standards, such as DIN, EN, IEC and ANSI.

Independent testers inspect the results and assign the appropriate proofs of suitability, such as approvals, evaluations or test certificates, to our products. In the Downloads area at www.obo-bettermann.com, you can view and download all the fire protection certificates of our products.



We like to make every effort for our fire tests! When we test our cable support systems that maintain the electrical supply in a fire, we test the entire cable system, consisting of the routing systems and cables with the integrated function of maintaining the supply of electricity. We subject the entire system to the practical test in a fire and test whether our products can withstand the temperatures of up to 1,000 °C.

Often, we even carry out such fire tests in the development phase of a product. The results are then taken into account when further developing the product. In the end, we have absolutely safe and practical solutions, which meet the requirements of the market.



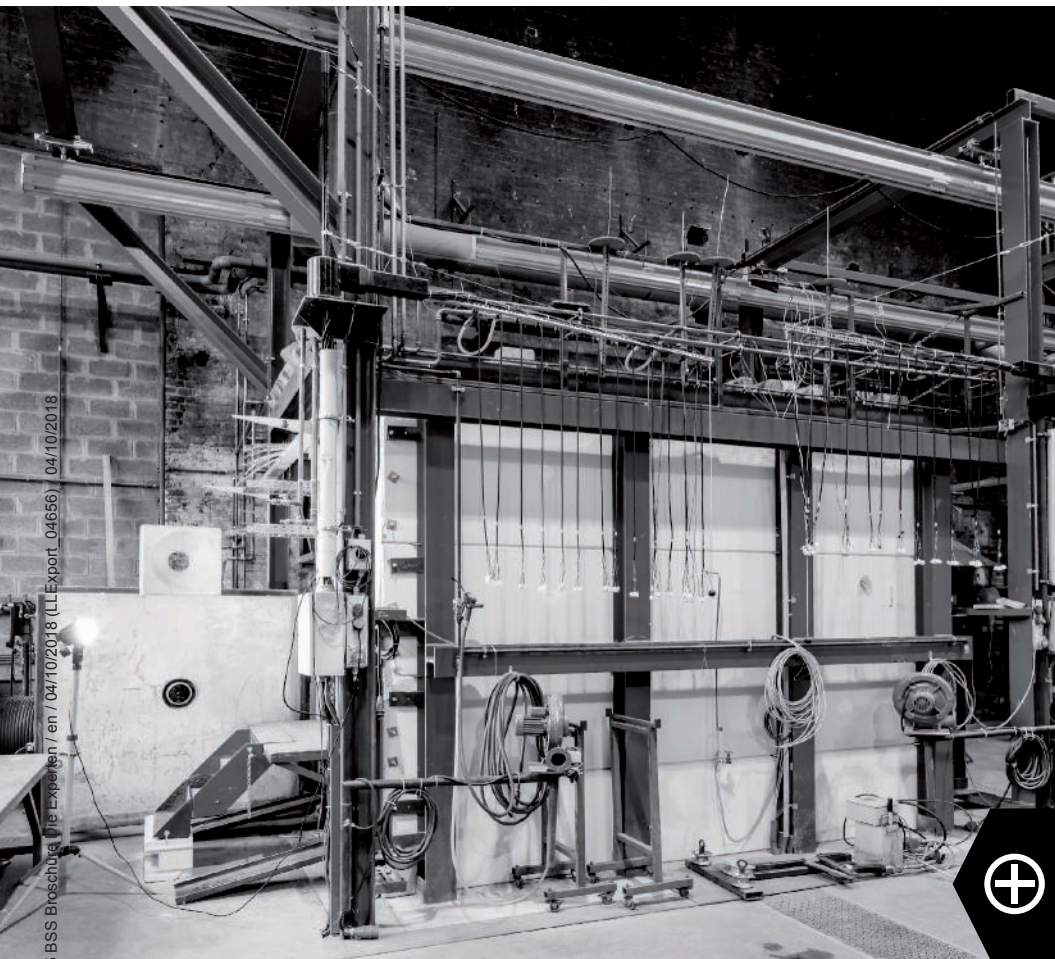

Our cooperation partners

To guarantee the best and safest quality, OBO works together with many partners in the field of fire protection:

- MPA NRW, Germany
- MPA Braunschweig, Germany
- MFPA Leipzig, Germany
- DIBt Berlin, Germany
- OIB Vienna, Austria
- FIRES, Slovakia
- CNBOP, Poland
- UL Chicago, USA



OBO support: Help from the fire protection experts

Forty years of experience in fire protection make OBO a reliable partner. We want to pass on our theoretical and practical knowledge to our customers and have developed a wide range of offers to do this:

Personal service:

- Telephone consultation and e-mail support
- Field service around the world
- Fire protection seminars

Online offer:

- Fire protection guide and catalogue
- Mounting instructions and films
- Selection aids
- Certificates
- OBO Construct app
- www.obo.eu/die-experten



Customer Service +49 (0)2371 7899-2000

Be it a first consultation, a concrete question or a comprehensive problem, via OBO Customer Service, you can reach a direct contact who can help you in any matter connected with fire protection. Our technically qualified Customer Service is in constant contact with our product managers and developers and can offer rapid help with practical solutions.

In the case of more comprehensive enquiries or tricky challenges, you will be forwarded to the appropriate fire protection expert. Or we can organise a member of our field service team to develop solutions with you on-site. You can obtain basic knowledge and information on the latest developments in fire protection at our seminars, at which OBO experts and external speakers will share their knowledge with you.

OBO Construct App

You can find "help to help yourself" on the Internet: Use the OBO Construct app to find out about the suitable insulation systems yourself. In addition, in the Downloads area of www.obo-bettermann.com, you will find all the proofs of use, mounting instructions and selection aids for our fire protection products available for use freely.

International service

Fire protection regulations differ from country to country. This is why our fire protection experts are in constant contact with our foreign subsidiary companies. You can also rely on our help in international construction projects.

40
YEARS
OF EXPERIENCE

"In Customer Service, we do not rely on flyers and catalogues, but give you concrete, solution-orientated advice."

Technical support

New fire protection guide

Our fire protection guide offers general and special information about the topic of fire protection and has been completely revised for you. In the guide, our OBO experts explain key basic principles, present problems with matching solution approaches and provide information on testing methods and certificates. Of course, we have included current developments, standards and legal requirements in the revised version. The fire protection guide offers helpful, new information for every level of knowledge.

Use our expert knowledge from 40 years of OBO fire protection for your application. You can order the new fire protection guide online at www.obo-bettermann.com.



40
YEARS
OF EXPERIENCE

OBO fire protection history

It's now 40 years ago that OBO took its first steps in the field of fire protection. In 1977, OBO engineers developed the first solutions in the field of insulation. Today, we can look back over many decades of experience and, with our products and knowledge, can cover the three aims of fire protection.

Now as then, we want to be pioneers: In 1987, we worked on the very first German standard for maintaining the supply of electricity in the event of fire. Today too, our experience and knowledge flows into new standards. We find solutions that always fulfil the current requirements of the industry and of construction law.

Rely on 40 years of fire protection experience! We look forward to celebrating our anniversary year with you!

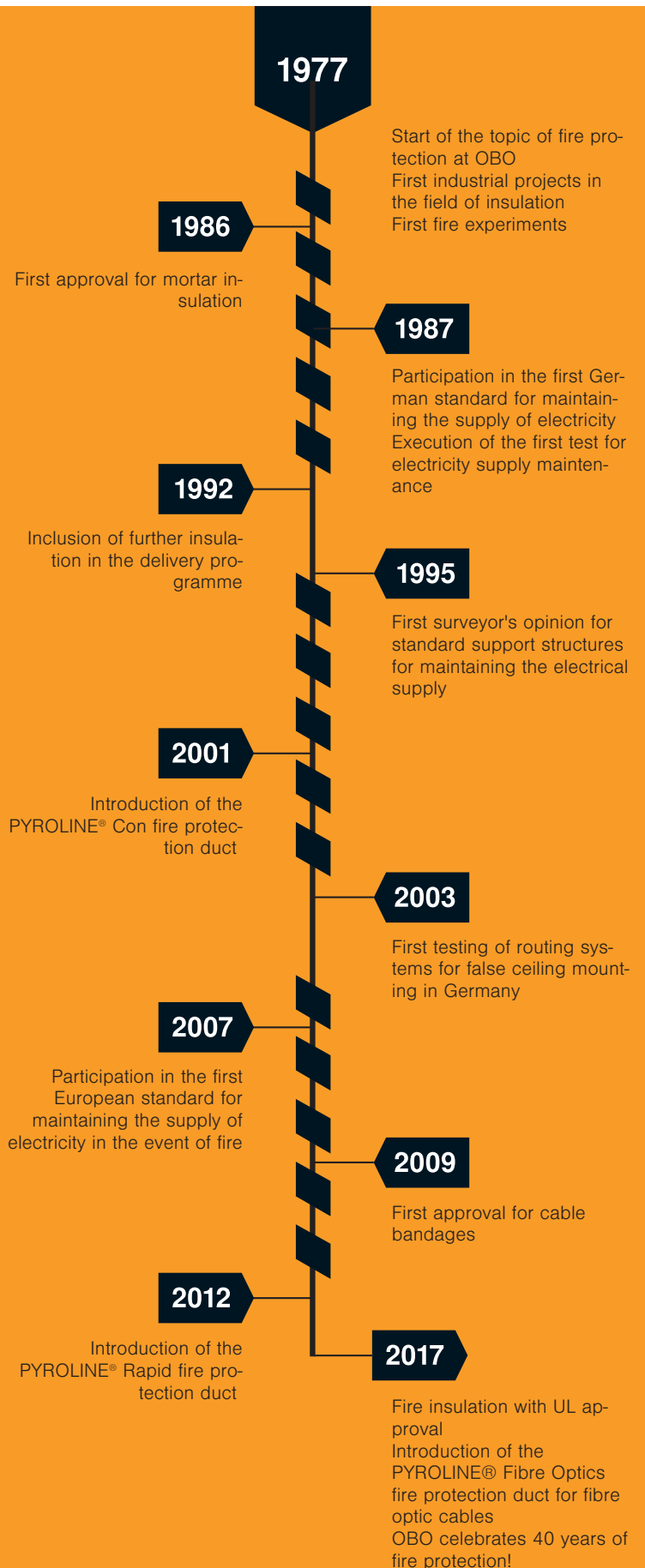

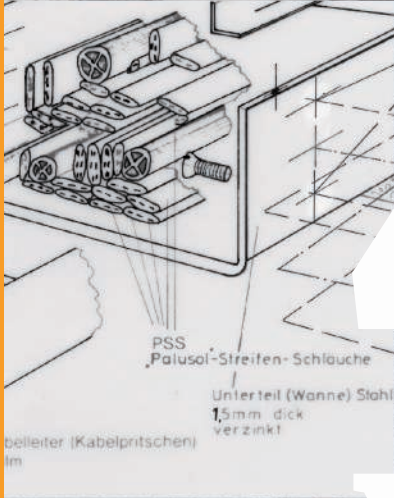
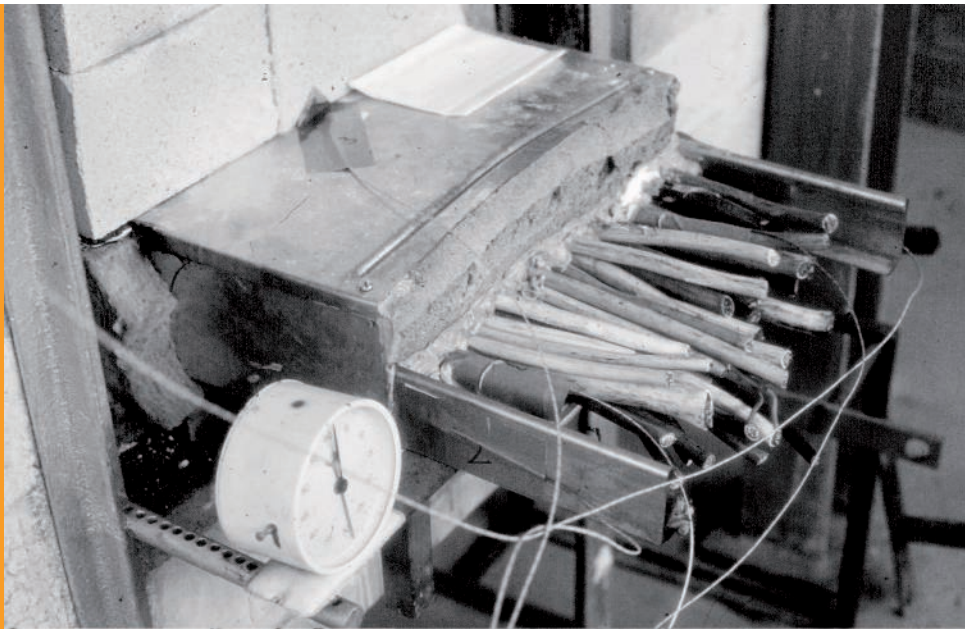

40 YEARS OF EXPERIENCE

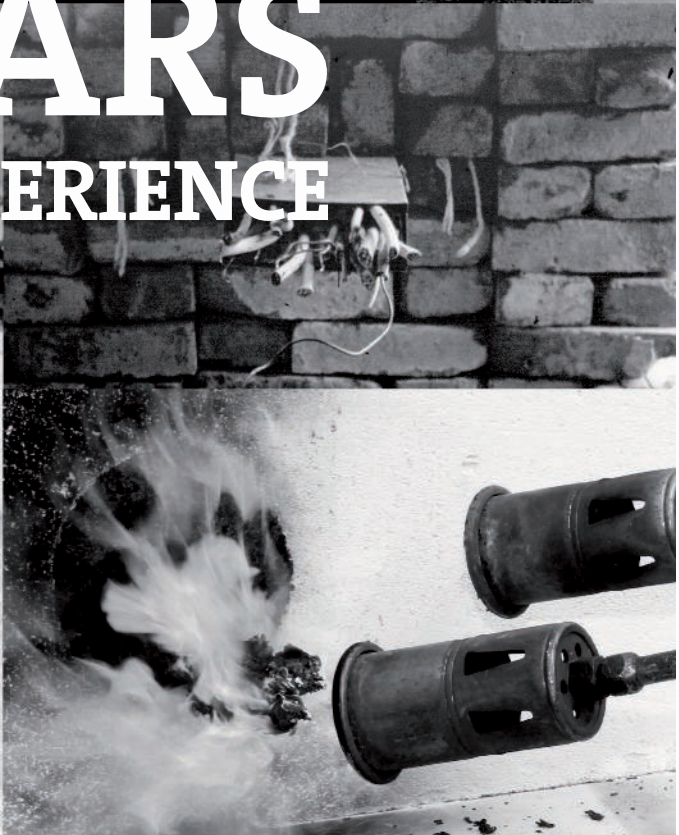

OBO Bettermann Holding GmbH & Co. KG
P.O. Box 1120
58694 Menden
GERMANY

Customer Service Germany
Tel.: +49 23 73 89 - 17 00
Fax: +49 23 73 89 - 12 38
export@obo.de

www.obo-bettermann.com

Building Connections

